

DELL™

POWERSHIELD™

MD1200 & MD1220

TECHNICAL GUIDEBOOK



Table of Contents

1	Product Comparison	3
1.1	Overview	3
2	New Features.....	3
3	System Overview	4
3.1	Customer driven product priorities.....	4
3.2	Product Positioning	4
3.3	PowerVault™ MD1200 and MD1220 Product Features Summary.....	5
4	Product Support	6
4.1	Host-RAID Adapter Support	6
4.2	Host Server Support.....	6
4.3	Management Software Support	6
4.4	Operating System Support	6
4.5	Drive Support	7
5	Chassis Overview	8
5.1	Dimensions and Weight.....	8
5.2	Front View and Features	9
5.3	Back View and Features.....	12
5.4	Hard Drive Indicators.....	13
5.5	Enclosure Management Module	14
5.6	Power Indicator Codes	16
5.7	Solution Configurations	16
5.8	Connecting the Enclosure	19
5.9	Field Replaceable Units (FRU).....	20
6	Environmental	20
6.1	Power Supply Specifications	20
6.1.1	Thermal management.....	21
6.1.2	Over-Temperature Shutdown	21
6.2	Environmental Specifications.....	22
7	Rack Information	22
7.1	Overview	22
7.2	Rack Rail Kit.....	22
8	Additional Information	23

1 Product Comparison

1.1 Overview

Evolution of Dell™ PowerVault™ DAS portfolio with the introduction of 6Gb/s SAS (SAS 2.0) in our JBOD arrays. These arrays will connect to Dell™ PowerEdge™ 11G servers using the Dell™ PowerEdge™ RAID (PERC) H800 Host-RAID Adapter. The MD1200 is follow-on to the MD1000, and the MD1220 is follow-on to the MD1120.

Table 1 shows a comparison between these versions.

Table 1. Comparison of MD1220 and MD1200 to previous MD1120 and MD1000

Feature/Spec	NEW MD1220	MD1120	NEW MD1200	MD1000
Rack Units	2U	2U	2U	3U
Slot Form Factor	2.5 inch	2.5 inch	3.5 inch	3.5 inch
Slots	24	24	12	15
Interface	6Gb (SAS 2.0)	3Gb	6Gb (SAS 2.0)	3Gb
Host-RAID Adapter	PERC H800	PERC 6/E	PERC H800	PERC 6/E PERC5/E
EMM	Dual	Dual	Dual	Dual
Power Supply/Fan Module	Dual auto-sensing	Dual	Dual auto-sensing	Dual
HDD Support	2.5 inch SAS HDD	2.5 inch SAS HDD	3.5 inch SAS HDD **2.5 inch SAS HDD	3.5 inch SAS HDD 3.5 inch SATA HDD
SSD Support**	**2.5 inch SAS SSD	N/A	**2.5 inch SAS SSD	N/A
Storage Management (min rev)	Open Manage (6.2)	Open Manage (5.4)	Open Manage (6.2)	Open Manage (4.5.1)
RAID Levels	0, 1, 5, 6, 10, 50, 60	0, 1, 5, 6, 10, 50, 60	0, 1, 5, 6, 10, 50, 60	0, 1, 5, 6, 10, 50, 60

2 New Features

The PowerVault™ MD1200 and MD1220 offer the following new features:

- 6Gb/s SAS (SAS 2.0)
 - Double the throughput performance
 - Self Encrypting Drives (SED)
- PERC H800 Host-RAID adapter
 - Increased IOPs performance
- Increased Density of the 3.5" (MD1200) enclosure (12 drive 2U)

** Available in Q3 2010

- Increased Capacity – Daisy chain up to 8 enclosures behind a PERC H800
- Increased Flexibility
 - Mix 2.5" (MD1220) and 3.5" (MD1200) enclosures behind a PERC H800
 - Mix 2.5" and 3.5" drives in the MD1200**
- Supports SAS Drives only; HDDs at 7.2K, 10K, and 15K rpm and SSD**

3 System Overview

3.1 Customer driven product priorities

- **Internal Storage no longer enough:** Server storage running out, server applications are beginning to bog down, need to move to an external, direct attach storage solution.
- **Single Server Applications:** Storage expansion for a single server where clustering and availability are not concerns.
- **Capacity Intensive Application Storage (MD1200):** Looking for storage to support very a large volume of data, great solutions for companies that need a low cost per GB for storage.
- **Performance Intensive Application Storage (MD1220):** Looking for storage to support very high performance, transaction intensive applications like e-mail, database, OLTP (online transaction processing), and data warehousing.
- **Space and Power Conservation (MD1220):** Have space or power constraints and looking for high efficiency per U of rack space

3.2 Product Positioning

- Dell™ PowerVault™ **MD1200** direct attached storage array offers versatility and high capacity storage for mainstream applications, with optimal performance in sequential (streaming) applications.
 - **Easy to expand your server capacity:** The PowerVault™ MD1200 is engineered to seamlessly expand the capacity of PowerEdge™ servers. This expansion array can support 12, 3.5 or 2.5 inch SAS HDDs or SSDs** drives in a 2U array and expands up to 8 arrays behind a single PERC H800 Host-RAID adapter.
 - **Versatility and flexibility to meet most business needs:** The PowerVault™ MD1200 is Dell's most versatile direct attach storage array. With the ability to mix 2.5 inch and 3.5 inch enclosures behind a single PERC H800 Host-RAID adapter, combined with support for 2.5 inch drives**, PowerVault™ MD1200 delivers capacity and performance to support most customer deployments.
- Dell™ PowerVault™ **MD1220**, the energy-efficient, small-form-factor (SFF), 2.5-inch drive expansion enclosure, provides the performance required for the most demanding applications in a simple, energy-efficient direct-attached storage array.
 - **Optimizing Performance, Enhancing Security While Doubling the Throughput:** The PowerVault™ MD1220 leverages SAS 2.0 technology, which doubles the throughput with a 6Gb/s SAS interface and offers performance optimization with automatic I/O load balancing across redundant paths and enhanced security with new self-encrypting drive (SED) support.
 - **Improved efficiency:** The PowerVault™ MD1220 improves energy efficiency over previous generation, with new 80PLUS(R) Silver Certified power supplies. This enhancement augments the efficiencies already gained with 2.5-inch drives and variable speed fans.

3.3 PowerVault™ MD1200 and MD1220 Product Features Summary

Table 2. PowerVault™ MD1200 and MD1220 Features and Descriptions

Feature	MD1200	MD1220
Rack Height	2U	2U
Host interface	6Gb/s SAS (SAS 2.0)	6Gb/s SAS (SAS 2.0)
Number of Drive bays	12 – 3.5"	24 – 2.5"
Expandability (daisy chain)	8 enclosures per PERC H800 (4 enclosures per port) for a total of 96 drives Redundant Path: up to 4 enclosures per PERC H800 Daisy-chain not supported with Split mode	8 enclosures per PERC H800 (4 enclosures per port) for a total of 192 drives Redundant Path: up to 4 enclosures per PERC H800 Daisy-chain not supported with Split mode
Manageability	In-Band via SES	In-Band via SES
Backplane Options	Unified (default) or Split mode	Unified (default) or Split mode
Drive Support	SAS HDD and SAS SSD**	SAS HDD and SAS SSD**
Host-RAID adapter	PERC H800	PERC H800
Cluster Support	PERC H800: No	PERC H800: No
Rack or Stand alone Tower	Rack Only	Rack Only
Drive Hot Plug support	Yes	Yes
Hot Plug Fans/blowers	Yes – Dual combined fan/power supply module	Yes – Dual combined fan/power supply module
Hot Plug Power supplies	Yes – Dual combined fan/power supply module	Yes – Dual combined fan/power supply module
SAF-TE, SES Support	SES only	SES only
Enclosure Management configurations	Dual Redundant – SBB 2.0 compliant	Dual Redundant – SBB 2.0 compliant
Power Supply configurations	Redundant Auto-Sensing	Redundant Auto-Sensing
Fans/blowers	Redundant	Redundant
Chassis Dimensions	Height 8.68 cm (3.41 inches) Width 44.63 cm (17.57 inches) Depth 60.20 cm (23.70 inches)	Height 8.68 cm (3.41 inches) Width 44.63 cm (17.57 inches) Depth 54.90 cm (21.61 inches)
Weight	Weight (max config) 28.39 kg (62.6 lb) Weight (empty) 8.84 kg (19.5 lb)	Weight (max config) 23.31 kg (51.4 lb) Weight (empty) 8.61 kg (19 lb)

** Available in Q3 2010

4 Product Support

4.1 Host-RAID Adapter Support

The PowerVault™ MD1200 and MD1220 require the PERC H800 for Server connectivity. The PERC H800 is a PCIe 2.0, dual port (2 x4), hardware RAID controller offering 512MB standard battery-backed cache and RAID level support for RAID 0, 1, 5, 6, 10, 50, and 60. The key features of the PERC H800:

- 6Gb/s SAS (SAS 2.0)
- Enables daisy-chaining up to 8 enclosures (4 per port)
- Enables mixing 2.5-inch and 3.5-inch enclosures in the same daisy-chain
- Enables Redundant Path with Automatic I/O load balancing
- Supports Self-Encrypting Drive (SED)
 - Requires specific SED drive part numbers

For additional details on PERC H800, visit the PERC web page at www.dell.com/PERC.

4.2 Host Server Support

The PERC H800 is supported with Dell™ 11th Generation PowerEdge™ Servers. Refer to Table 3 for PowerEdge™ Servers that support the PERC H800. For the latest PERC H800 support matrix, visit the PERC web page at www.dell.com/PERC.

Table 3. PowerEdge™ Servers that support PERC H800 (at initial product launch)

Rack Servers	Tower Servers
PE R210	PE T310
PE R410	PE T410
PE R510	PE T610
PE R610	PE T710
PE R710	

4.3 Management Software Support

The Dell™ PowerVault™ MD1200 and MD1220 enclosures are managed via the management software provided for the PERC H800. The Dell™ PERC H800 is supported with Dell™ 11th Generation PowerEdge™ Servers and managed via OpenManage™ Storage Management (minimum version 6.2).

4.4 Operating System Support

The Dell™ PowerVault™ MD1200 and MD1220 enclosures, via PERC H800, support all major enterprise server operating systems consistent with the Dell™ 11G PowerEdge™ servers and Dell™ OpenManage™ Storage Management (minimum version 6.2) software. This includes Microsoft™ Windows™ Server 2003 and 2008, Red Hat™ Linux 4 and 5, and SUSE™ Linux 10 and 11. For more specific details on supported operating systems, refer to the PERC web page (www.dell.com/PERC) or OpenManage™ 6.2 support matrix.

4.5 Drive Support

Dell™ PowerVault™ MD1200 and MD1220 enclosures support SAS hot-pluggable HDDs (hard-disk drives) and SSDs** (solid-state drives). MD1200 allows for both 3.5-inch and 2.5-inch** form factor drives, and MD1220 allows for 2.5-inch form factor drives. Refer to Table 4 for Drive Support details.

Table 4. Drive Support

Form Factor	Speed (rpm)	Capacity (GB)
2.5" SAS HDDs up to 6Gb/s SSDs up to 3Gb/s	7,200	500 GB
	10,000	146 GB 300 GB
	15,000	73 GB 146 GB
	SSD**	150 GB
3.5" SAS HDDs up to 6Gb/s	7,200	500 GB 1000 GB (1 TB) 2000 GB (2 TB)
	15,000	300 GB 450 GB 600 GB

- SATA interface drives are not supported with the Dell™ PowerVault™ MD1200 and MD1220 enclosures.
- 6Gb/s SAS interface HDDs and 3Gb/s SAS interface SSDs are configured in the MD1200 and MD1220, from Dell's factory, and 3Gb/s SAS interface HDDs are supported in the field with the supported MD1200 or MD1220 carrier.
- The front bezel of the system contains a lock. A locked bezel secures the system hard drives.

5 Chassis Overview

5.1 Dimensions and Weight

The PowerVault™ MD1200 and MD1220 enclosures use a rack mount 2U chassis.

Dimensions and Weight

Table 5. Detailed Dimensions (mm)

Model Number	Xa	Xb	Y	Za with bezel	Za with bezel	Zb	Zc	Max Sys Weight (kg)
PV MD1200	481.5	446.3	86.8	38.0	19.0	561.0	602.0	28.39
PV MD1220	481.5	446.3	86.8	38.0	19.0	508.0	549.0	23.31

Figure 1. MD1200 and MD1220 Dimensions

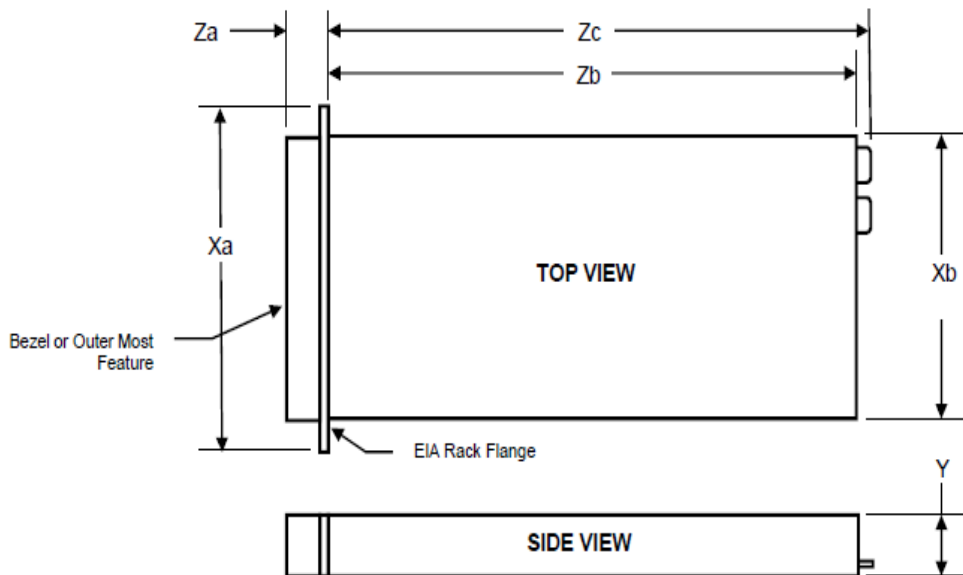

PowerVault™ MD1200: Weight (maximum configuration) 28.39 kg (62.6 lb)

PowerVault™ MD1220: Weight (maximum configuration) 23.31 kg (51.4 lb)

5.2 Front View and Features

Figure 2. MD1200 Front View and Features

12 – 3.5" or 2.5" SAS drives



Front Panel Features and Indicators — Dell™ PowerVault™ MD1200

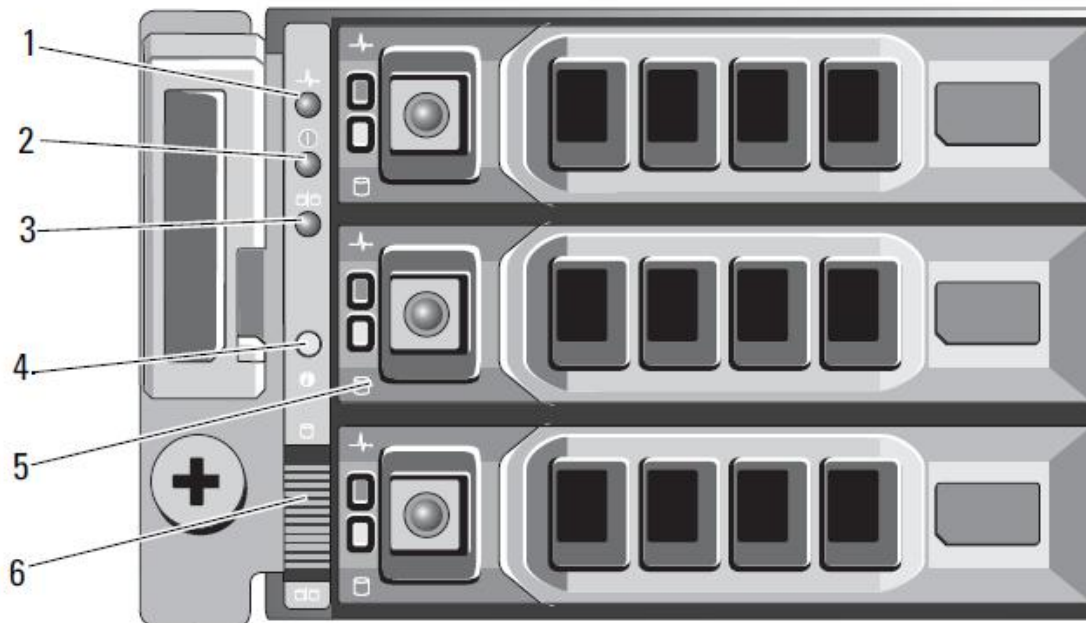

Figure 3. MD1220 Front View and Features

24 - 2.5" SFF SAS drives

2U



Front Panel Features and Indicators — Dell PowerVault MD1220



Table 6. MD1200 and MD1220 Front Panel Feature Description





FRONT PANEL / BEZEL INDICATOR AND FEATURE DESCRIPTION			
Item	Indicator, Button, or Connector	Icon	Description
1	Enclosure status LED		The enclosure status LED lights when the enclosure power is on. Lights blue during normal operation and when the host server is identifying the enclosure. Blinks blue when a host server is identifying the enclosure or when the system identification button is pressed. Lights amber when the enclosure is turned on or is reset. Blinks amber when the enclosure is in the fault state.
2	Power LED		The power LED lights when at least one power supply is supplying power to the enclosure.
3	Split Mode LED		The split mode LED lights when the enclosure is in a split-mode configuration. If the LED is not lit, it indicates that the enclosure is in a unified-mode configuration.
4	System Identification Button		The system identification button on the front control panel can be used to locate a particular enclosure within a rack. When the button is pushed, the system status indicators on the control panel and the EMM blinks blue until the button is pushed again.
5	Hard Drives		PowerVault™ MD1200—Up to 12 SAS hot-swappable drives. PowerVault™ MD1220—Up to 24 2.5-inch SAS hot-swappable drives.
6	Enclosure Mode Switch		When set in the top position, the enclosure is configured in unified mode. When set in the bottom position, the enclosure is configured in split mode.

Figure 4. MD1200 and MD1220 Front Bezel Feature and Indicators



5.3 Back View and Features

Figure 5. MD1200 / MD1220 Back View and Features

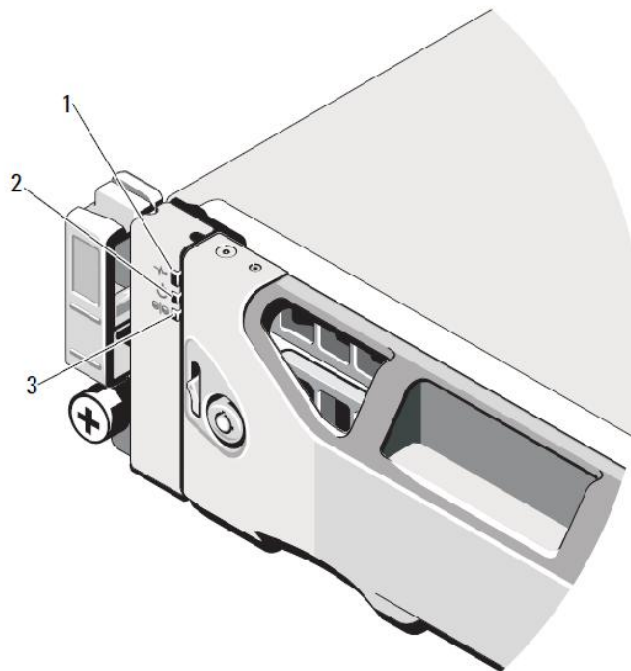
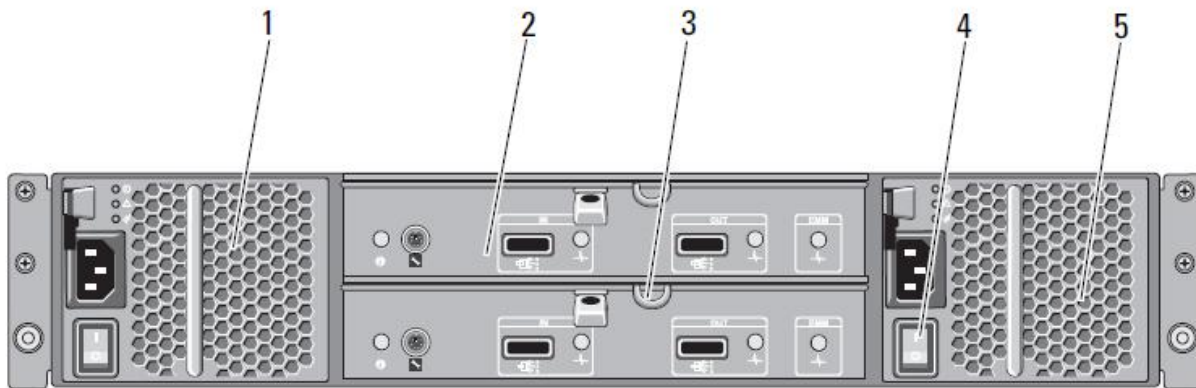
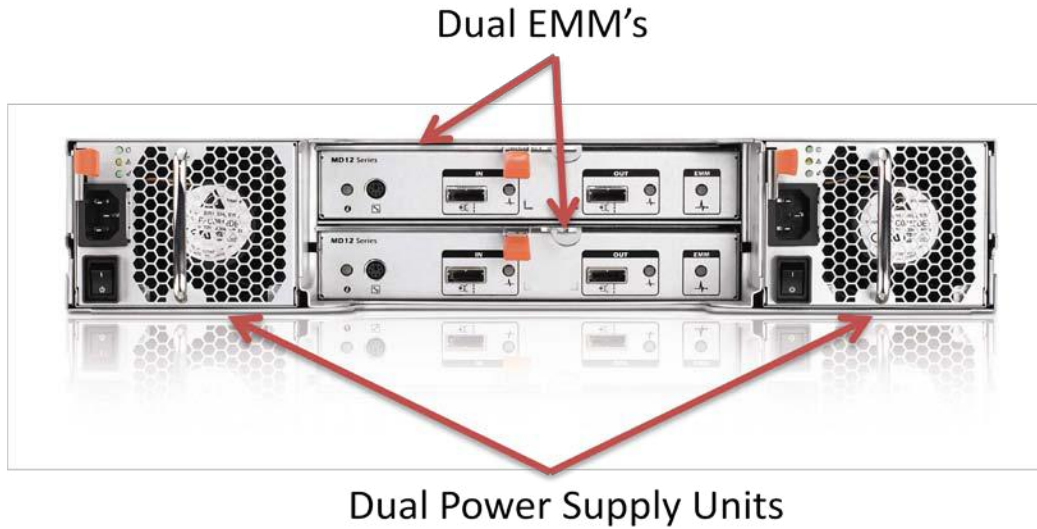

Table 7. MD1200 and MD1220 Back Panel Feature Description

BACK PANEL INDICATOR AND FETAURE DESCRIPTION			
Item	Indicator, Button, or Connector	Icon	Description
1	Power supply/cooling fan module	PS 1	600 W power supply For more information, see "Power Indicator codes" section
2	Primary enclosure management module (EMM)	EMM 0	The EMM provides: A data path between the enclosure and the host server. Enclosure management functions for your enclosure
3	Secondary EMM	EMM 1	
4	Power switches (2)		The power switch controls the power supply output to the enclosure
5	Power supply/cooling fan module	PS 2	600 W power supply

** Available in Q3 2010

5.4 Hard Drive Indicators

Figure 6. Hard Drive Indicators (includes HDD and SSD)



- 1 hard-drive activity indicator (green) 2 hard-drive status indicator (green and amber)

Table 8. Drive Indicator Description

Drive-Status Indicator Pattern (RAID Only)	Condition
Blinks green two times per second	Identify drive/preparing for removal
Off	Drive ready for insertion or removal NOTE: The drive status indicator remains off until all hard drives are initialized after system power is turned on. Drives are not ready for insertion or removal during this time. The Dell™ PowerEdge™™ RAID controller PERC H800 may take up to a minute to discover and initialize all the hard drives.
Blinks green, amber, and off	Drive predicted failure
Blinks amber four times per second	Drive failed
Blinks green slowly	Drive rebuilding
Steady green	Drive online
Blinks green three seconds, amber three seconds, and off six seconds.	Rebuild aborted

5.5 Enclosure Management Module

Each EMM provides the following data path and enclosure management functions for the enclosure:

- Monitoring and controlling enclosure environment elements such as temperature, fan, power supplies, and enclosure LEDs.
- Controlling access to hard drives.
- Communicating enclosure attributes and states to the host server.

Figure 7. Enclosure Management Module

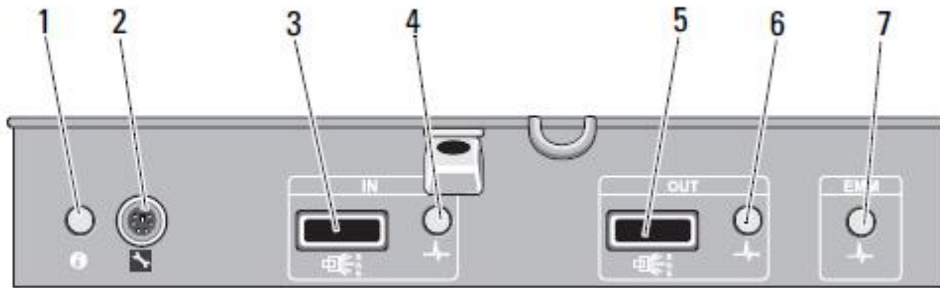

Table 9. EMM Indicator Description

EMM INDICATOR AND FEATURE DESCRIPTION			
Item	Indicator, Button, or Connector	Icon	Description
1	System Status Indicator		Blinks blue when the system identification button is pushed. You can identify a particular enclosure in a rack using the system identification indicator.
2	Debug Port		For engineering use only.
3	SAS Port (In)	IN	Provides SAS connections for cabling the host or an up-chain expansion enclosure (unified mode only).
4	In port link status		Lights green when all the links to the port are connected. Lights amber when one or more links to the port are not connected. The LED remains off if enclosure is not connected.
5	SAS Port (Out)	OUT	Provides SAS connections for cabling to the next down chain expansion enclosure in a daisy chain (unified mode only). NOTE: The SAS port Out is disabled if the enclosure is running in a split-mode configuration.
6	Out port link status		Lights green when all the links out of the port are connected. Lights amber when one or more links out of the port are not connected. The LED remains off if enclosure is not connected.
7	EMM Status LED		Lights green when the EMM is functioning properly. Lights amber when the enclosure does not boot or is not properly configured. Blinks green (On 250 ms* Off 250 ms) when a firmware download is in progress. Blinks green (On 1000 ms+ Off 1000 ms) when a peer auto-

** Available in Q3 2010

EMM INDICATOR AND FETAURE DESCRIPTION			
Item	Indicator, Button, or Connector	Icon	Description
			<p>update is in progress. Blinks amber (On 250 ms Off 250 ms [two times]; Off 1000 ms) when the enclosure is unable to communicate with enclosure devices. Blinks amber (On 250 ms *Off 250 ms [four times]; Off 1000 ms) when a firmware update fails. Blinks amber (On 250 ms Off 250 ms [five times]; Off 1000 ms) when the firmware versions are different between two EMMs in an enclosure. *indicates that the LED blinks fast. +indicates that the LED blinks slowly.</p>

Enclosure Failover When Two EMMs are Installed

If two EMMs are installed, a certain degree of failover is offered. Control and monitoring of the enclosure elements can be transferred from one EMM to another in the event of an EMM failure. A failover occurs whenever communication is lost between an EMM and its peer. In the event of a peer EMM failure, the surviving EMM activates the amber status LED of the failed EMM. The surviving EMM then takes over the responsibility of enclosure management, which includes monitoring and control of the audible alarm, enclosure LEDs, power supplies, and fans. When a failed EMM is replaced, enclosure management functions do not automatically return to the replaced EMM unless an additional failure occurs that triggers another failover event.

Note: When the enclosure is configured with dual EMMs in a redundant path configuration, all drives are still accessible, even after an EMM failure, since the EMMs are joined mode via the PERC H800 redundant path. When the enclosure is configured in split mode, only half of the drives are accessible in the event of an EMM failure.

EMM Thermal Shutdown

If critical internal temperatures are reached, the enclosure shuts down automatically through either a thermal shutdown command issued by the EMM firmware or through a command from Dell™™ OpenManage™ Server Administrator (OMSA).

Enclosure Alarms

An audible alarm is activated if any of the fault conditions listed below occur. The alarm sounds continuously if:

- More than one fan has failed or a power supply/cooling fan module is not installed.
- One or more temperature sensors are in critical range.

The alarm sounds every 10 seconds if:

- One power supply has failed.
- One cooling fan has failed.
- One or more temperature sensors are in warning range.
- One EMM has failed.

NOTE: The alarm is disabled by default. To enable the alarm, change the default setting in OMSA. For more information, see the OMSA documentation.

5.6 Power Indicator Codes

Figure 8. Power Indicator Codes

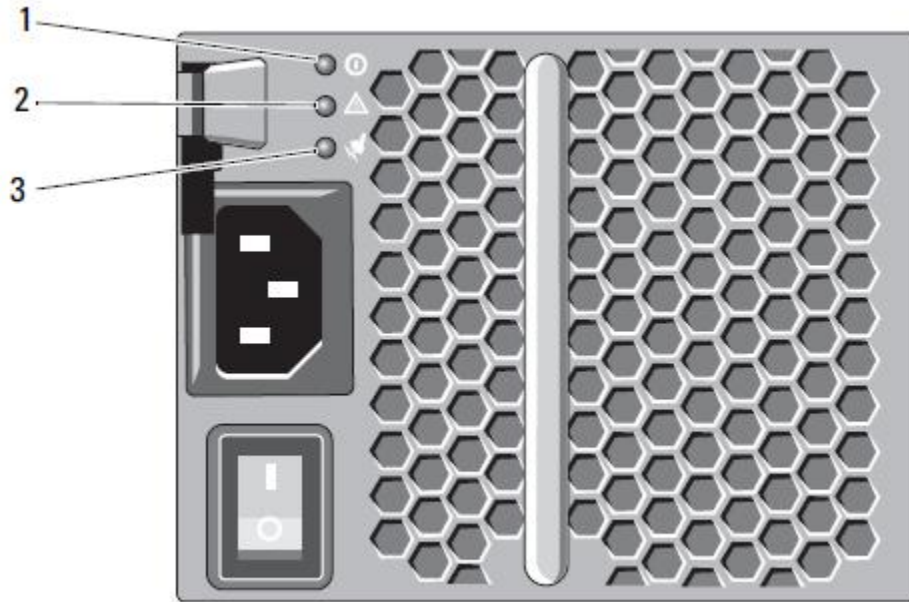





Table 10. Power Indicator Description

POWER INDICATOR AND FEATURE DESCRIPTION			
Item	Indicator, Button, or Connector	Icon	Description
1	DC Power		The LED lights green when the DC output voltage is within the limit. If this LED is off, it indicates that the DC output voltages are not within the limit.
2	Power supply/cooling fan fault		The LED lights amber when the DC output voltage is not within the limit or a fault with the fan is detected. If this LED is off, it indicates that no fault condition is present.
3	AC Power		The LED lights green when the AC input voltage is within the limit. If this LED is off, it indicates either there is no power or the AC input voltage is not within the limit.

5.7 Solution Configurations

The PowerVault™ MD1200 and MD1220 enclosures can be cabled in either a unified-mode configuration or in a split-mode configuration.

- In a unified-mode configuration the enclosure is connected to one host, for example, a server with a controller card. The enclosure can be one of up to four enclosures daisy-chained to a single port on the controller card in the host server. The enclosure can also be connected in a **redundant path** mode with two connections to single host server. Redundant path is recommended since it provides cable redundancy and better performance with automatic I/O load balancing. See Figure 9 and Figure 10 for cabling diagrams of unified mode configurations.

- In a split-mode configuration the enclosure is connected to either two host controllers or two ports on a single host controller. The enclosure can be connected to two different host servers in a split mode configuration. Each server sees the enclosure as an independent device with half of the total enclosure slot capacity. Table 10 lists the drives that are controlled by each enclosure management module (EMM) in a split-mode configuration. See Figure 11 for a cabling diagram of a split-mode configuration.

The operating mode is selected using the enclosure mode switch on the front panel of the enclosure.

NOTE: The enclosure mode switch must be set to either unified mode or split mode before the enclosure is turned on. Changing the configuration mode after turning on the enclosure has no effect on the enclosure configuration until the enclosure is rebooted.

NOTE: Clustering is not supported on PowerVault™ MD1200 and PowerVault™ M1220 enclosures.

Figure 9. EMM Cabling Diagram in Unified Mode (Single Path)

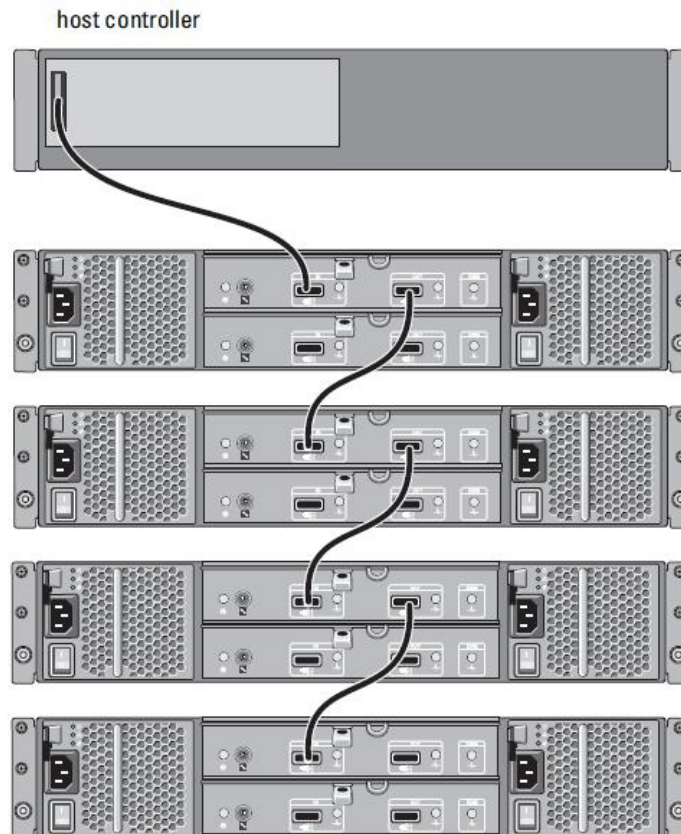

Figure 10. EMM Cabling Diagram in Unified Mode (Redundant Path) - *RECOMMENDED*

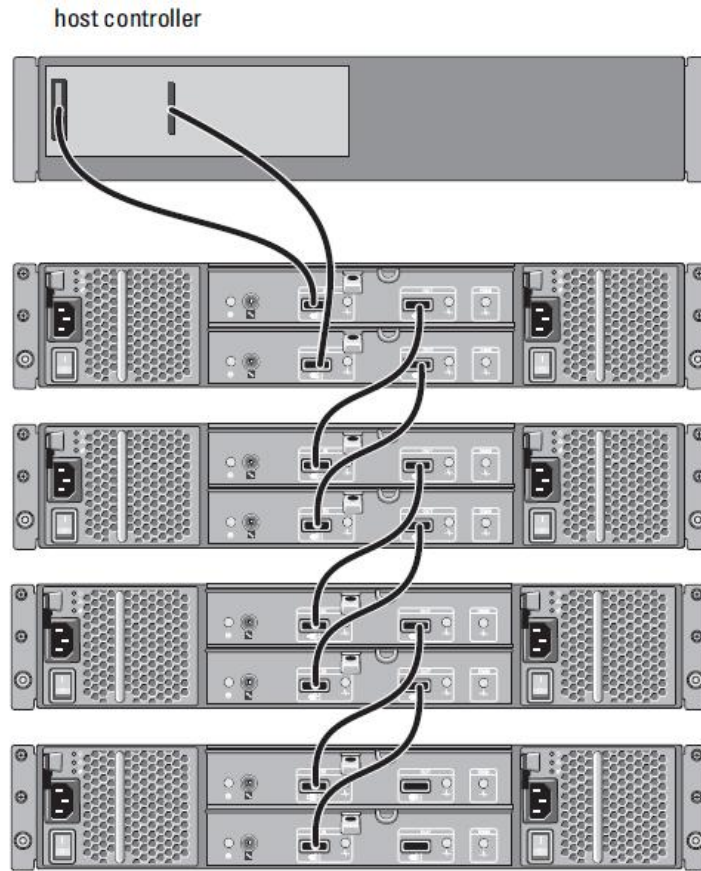

Figure 11. EMM Cabling Diagram in Split Mode

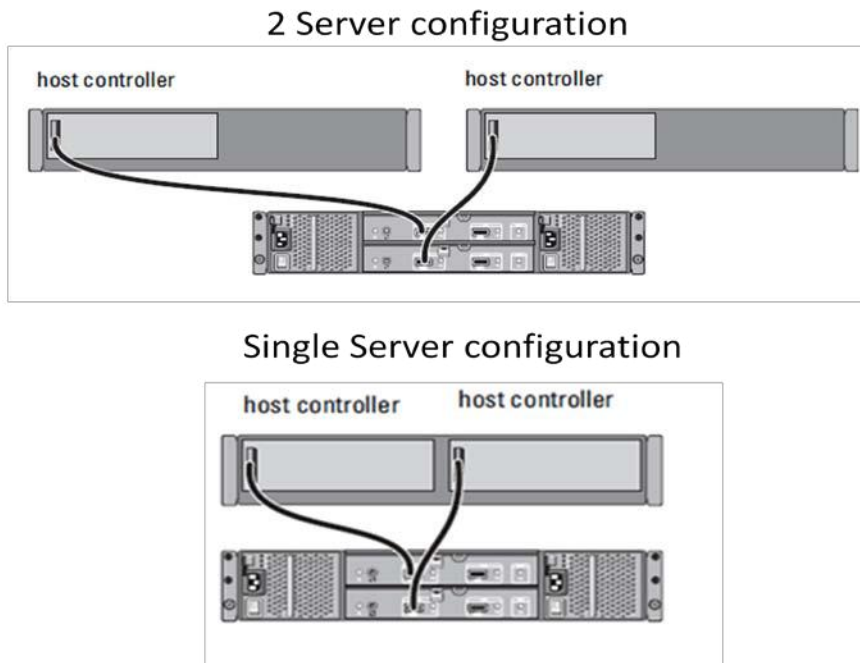

Table 11. Split Mode Configuration

Enclosure	EMM0	EMM1
Dell™ PowerVault™ MD1200	Drives 6 to 11	Drives 0 to 5
Dell™ PowerVault™ MD1220	Drives 12 to 23	Drives 0 to 11

5.8 Connecting the Enclosure

Dell™ PowerVault™ MD1200 and MD1220 enclosures standardize on the 6Gb/s (SAS 2.0) Mini-SAS cable (SFF 8088). The Mini-SAS cable is unique from the SAS cable used with the previous generation Dell™ PowerVault™ MD1000 and MD1120 enclosures. See transition comparison in Figure 12.

Figure 12. Mini-SAS Cable Transition

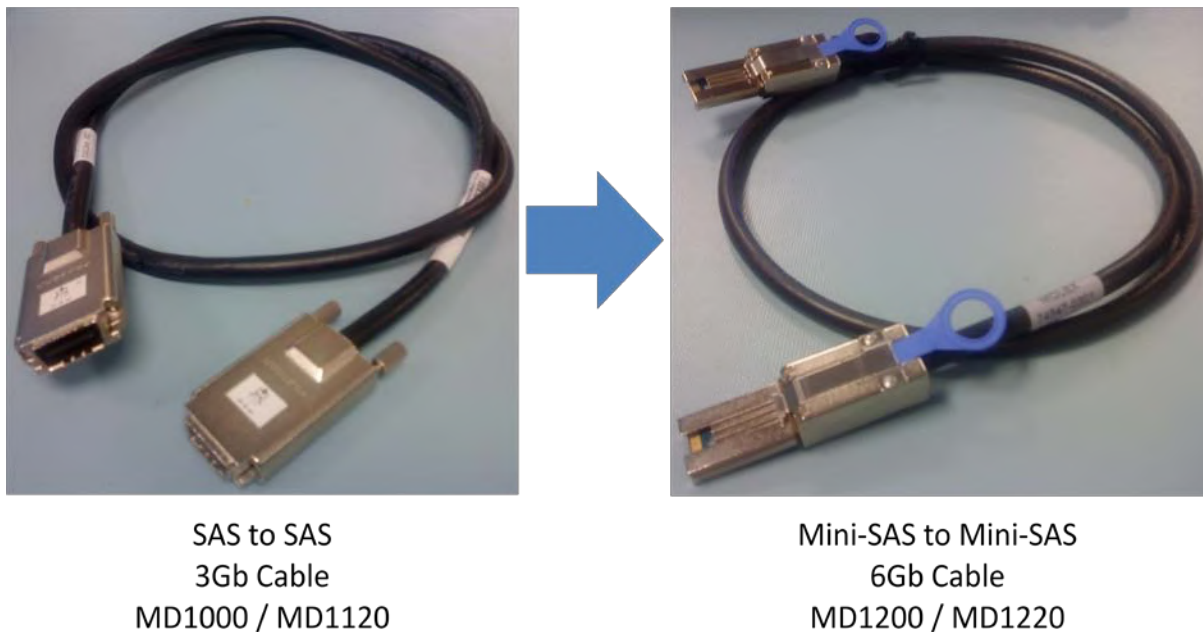

- Connectors on both ends of the SAS cable are universally keyed. Either end of the cable can be connected to the EMM or the RAID controller.
- To remove the SAS cable, pull the pull-tab to release the cable from the connector on the EMM and the host system. See Figure 13.

Figure 13. Connecting a Mini-SAS Cable

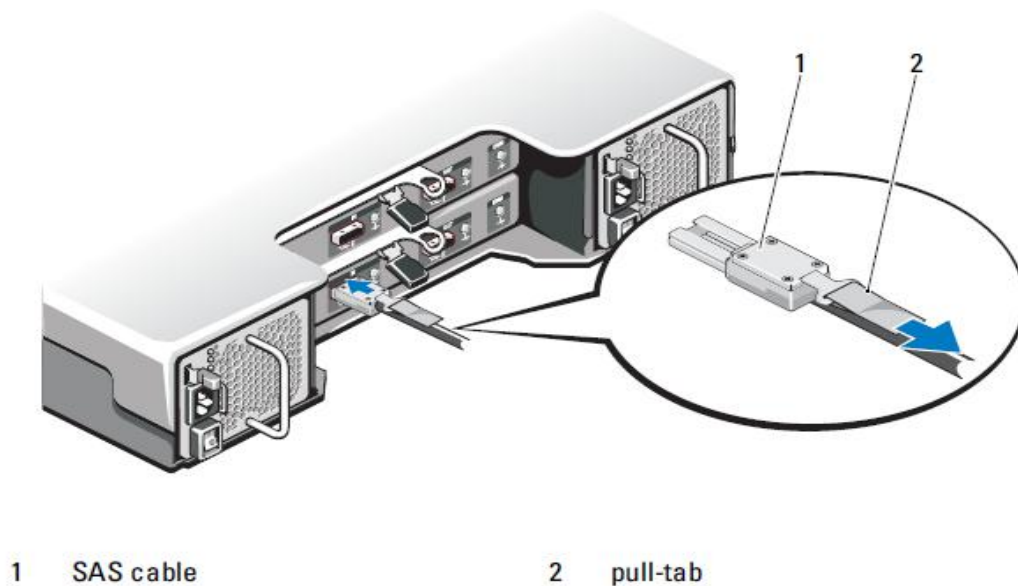

5.9 Field Replaceable Units (FRU)

Hot swap HDD and SSD, Power Supply Units (power supply/cooling fan modules), Enclosure Management Modules (EMMs), Control Panel and Backplane are the primary field replaceable units on the Dell™ PowerVault™ MD1200 and MD1220.

NOTE: For additional detailed instructions on installing and removing enclosure components, refer to the PowerVault™ MD1200 and MD1220 Hardware Owner's manual and Getting Started Guide at support.dell.com under manuals.

6 Environmental

6.1 Power Supply Specifications

The PowerVault™ MD1200 and MD1220 power supply is rated at 600 W. It operates on input voltages ranging from 100 – 240 V, auto-switching to the sensed line level.

- EMC classification is Light Industry
- FCC classification is Class A

Table 12. Power Supply Specifications

AC Characteristics									
INPUT PARAMETER	Requirement								
Input Voltage Range	90 – 264 VAC								
Input Frequency	47 – 63 Hz								
Peak Inrush Current	55 A for 10ms or less, 25 A for 10-150ms								
Power Factor over full AC input range	0.9 @ output load > 90%								
Minimum Efficiency measured 20%, 50% and 80% output load over full range of AC input and environmental conditions	Must Meet Climate Savers requirements: <table border="1"> <thead> <tr> <th><u>Load Condition</u></th> <th><u>Efficiency</u></th> </tr> </thead> <tbody> <tr> <td>20%</td> <td>87%</td> </tr> <tr> <td>50%</td> <td>90%</td> </tr> <tr> <td>100%</td> <td>87%</td> </tr> </tbody> </table>	<u>Load Condition</u>	<u>Efficiency</u>	20%	87%	50%	90%	100%	87%
<u>Load Condition</u>	<u>Efficiency</u>								
20%	87%								
50%	90%								
100%	87%								
Peak Output Power	600 Watts								

6.1.1 Thermal management

The cooling system for the enclosure is designed to allow all components (power supplies, EMMs, HDDs, SSDs etc.) to meet their full operating specifications. There may be up to four fans in each power supply/fan module. This configuration provides N+1 fan redundancy, meaning that the enclosure can be sufficiently cooled for normal operation even if one fan fails.

Firmware shall continuously monitor the temperature sensors within the enclosure and take proper actions to throttle the fans in order to maintain optimal operating temperature.

6.1.2 Over-Temperature Shutdown

In order to prevent potential damage to the drives and subsequent loss of data, the power supply has the capability to shut itself down or be shut down by the EMM, through embedded firmware or host management software such as Dell™ Open Manage Storage Management, in the event of an over-temperature condition. When the power supply incorporates its internal thermal shutdown feature, it will automatically restart when the over temperature condition no longer exists. Hysteresis of at least 5 degrees is employed to prevent a frequent toggling on and off of the outputs.

6.2 Environmental Specifications

Table 13. Environmental Specifications

Temperature	
Operating	10° to 35°C (50° to 95°F) with a maximum temperature gradation of 10°C per hour Note: For altitudes above 2950 feet, the maximum operating temperature is de-rated 1°F/550 ft.
Storage	-40° to 65°C (-40° to 149°F) with a maximum temperature gradation of 20°C per hour
Relative Humidity	
Operating	20% to 80% (non-condensing) with a maximum humidity gradation of 10% per hour
Storage	5% to 95% (non-condensing) with a maximum humidity gradation of 10% per hour
Maximum Vibration	
Operating	0.25 G at 3 – 200 Hz for 15 min
Storage	0.5 at 3 – 200 Hz for 15 min
Maximum Shock	
Operating	One shock pulse in the positive z axis (one pulse on each side of the system) of 31 G for 2.6 ms in the operational orientation
Storage	Six consecutively executed shock pulses in the positive and negative x, y, and z axes (one pulse on each side of the system) of 71 G for up to 2 ms
Altitude	
Operating	-16 to 3048 m (-50 to 10,000 ft) Note: For altitudes above 2950 feet, the maximum operating temperature is de-rated 1°F/550 ft.
Storage	-16 to 10,600 m (-50 to 35,000 ft)
Airborne Contaminant Level	
Class	G2 or lower as defined by ISA-S71.04-1985

7 Rack Information

7.1 Overview

The chassis dimensions shall adhere to CEA-310-E and Server System Infrastructure (SSI) specifications. Dimensional constraints of the chassis require that the chassis be 2U in height, and comply in width to fit a Dell™ rack. Drives are accessible from the front, while power supply/fan modules, backplane, and EMMs are accessible from the rear.

7.2 Rack Rail Kit

Provisions for a rack rail kit are incorporated into the chassis design. The chassis, front panel, and rack kit, when fully assembled together and placed in a rack, must be in compliance with DELL™ Rack Design Guidelines Version 1.1. All critical envelope dimensions referenced in this document assume the inclusion of the rack kit and bezel. Both VersaRail and RapidRail kits are available.

** Available in Q3 2010

8 Additional Information

- **Non-Dell drive lock-out** – In order to ensure the highest quality products and best customer experience, the PERC H800 will not allow for non-Dell™ SAS HDDs or SSDs to be initialized or configured in a Dell™ PowerVault™ MD1200 or MD1220.
- **Backward Compatibility (MD1200)** - The PowerVault™ MD1200 does not provide backward compatible support for connecting to previous generation adapters (PERC 5/E or PERC 6/E) or daisy-chaining with previous generation enclosures (MD1000, MD1120, MD3000, MD3000i). MD1200 does support a drive carrier that is common with the Dell™ 11th Generation PowerEdge™ servers. The previous generation PowerVault™ MD1000 carrier is not compatible with the MD1200.
- **Backward Compatibility (MD1220)** - The PowerVault™ MD1220 does not provide backward compatible support for connecting to previous generation adapters (PERC 5/E or PERC 6/E) or daisy-chaining with previous generation enclosures (MD1000, MD1120, MD3000, MD3000i). The MD1220 supports a drive carrier that is common with the Dell™ 11th Generation PowerEdge™ servers and the previous generation PowerVault™ MD1120.
- **Enclosure Migration and Drive Format** – The PowerVault™ MD1200 and MD1220 will not be supported behind Dell's 3Gb/s PowerVault™ External RAID enclosures, MD3000 and MD3000i.
- **Audible alarm** – The PowerVault™ MD1200 and MD1220 support an audible alarm within the enclosure (must be enabled via OMSS / PERC H800).
- **EMM blank** – An EMM blank must be installed in EMM1 position if a second EMM is not installed. This is required for proper airflow. In order to remove the EMM blank; you will need to remove EMM0 to access a release latch (see Figure 14) for blank. This ensures the customer shuts down the enclosure before making any configuration changes that could but data at risk.

Figure 14. Latch

